

# Perimeters of Compound Shapes 2

(with lengths of sides)

TransferReady.co.uk



Helping you get ready for the Transfer Test

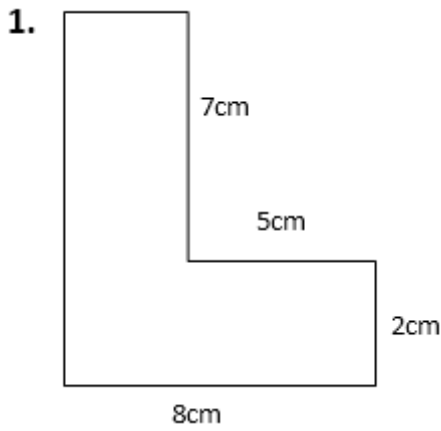

Answer \_\_\_\_\_ cm

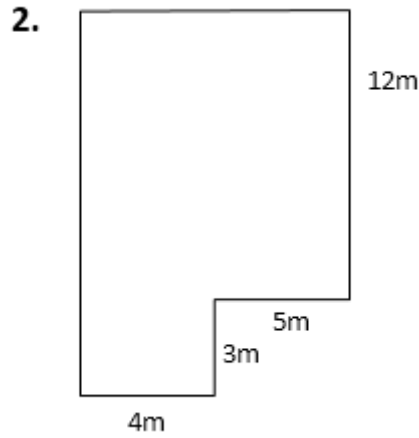

Answer \_\_\_\_\_ m

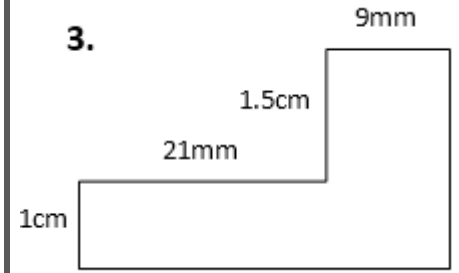

Answer \_\_\_\_\_ mm

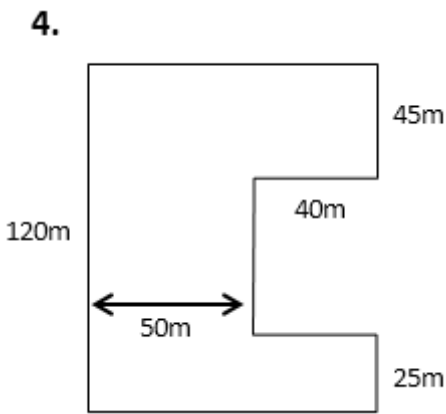

Answer \_\_\_\_\_ m

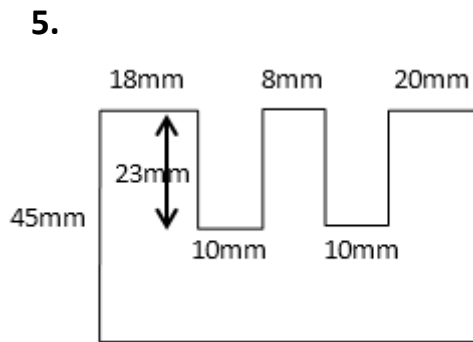

Answer \_\_\_\_\_ mm

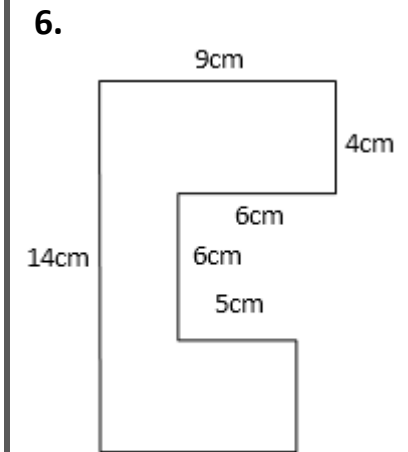

Answer \_\_\_\_\_ cm

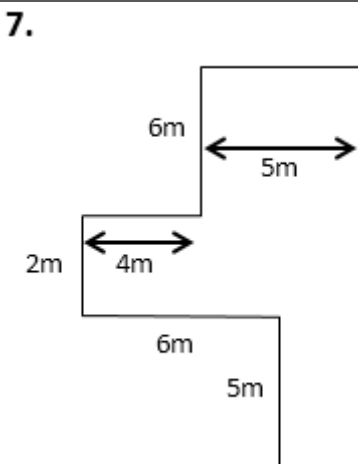

Answer \_\_\_\_\_ m

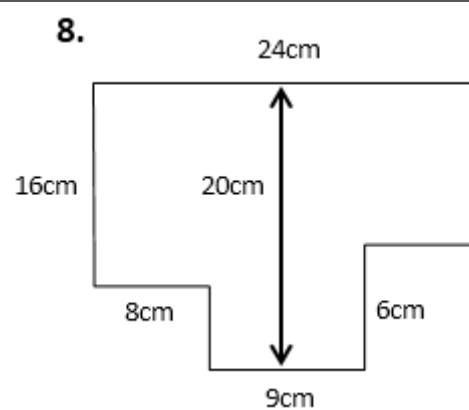

Answer \_\_\_\_\_ cm

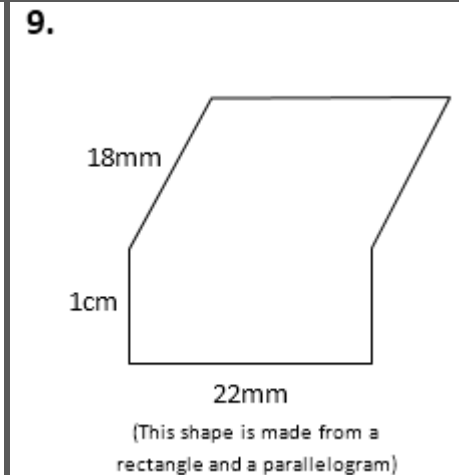

Answer \_\_\_\_\_ mm